

*Luxman*

SUPER AUDIO CD PLAYER

**D-05**

*Owner's Manual*



## Contents

Precautions . . . . .	1
Features Of This Unit . . . . .	3
About Discs This Unit Can Play Back . . . . .	5
Before Use . . . . .	7
Names and Functions of Part . . . . .	9
Connections . . . . .	21
How to Play Back Discs . . . . .	23
Stop/Pause the Playback . . . . .	25
Skip/Fast-forward/Rewind . . . . .	27
Direct Search . . . . .	29
Repeat Playback . . . . .	31
Program Playback . . . . .	33
Random Playback . . . . .	37
Disc Information/Zoom . . . . .	39
Detailed Settings . . . . .	41
BLOCK DIAGRAM . . . . .	47
Specifications . . . . .	48
Before You Ask For Repair Services . . . . .	49

---

---

# Precautions

---

## **DO NOT move this unit during playback.**

During playback, the disc is rotating at high speed. Do not try to lift or move this unit as the disc may be damaged.

## **When moving this unit**

You must remove the disc and close the disc tray when moving this unit.

Then, press the OPERATION switch, and after “-STANDBY-” disappears from the display, unplug the power cord from the AC outlet.

If the unit is moved with a disc remaining inside, this can cause a malfunction.

## **Location for installation**

- Choose a stable place near the stereo system that is to be used in combination with this unit.
- Do not install this unit near a television or color monitor. Keep this unit away from such devices as cassette decks that are subject to magnetism.
- Install this unit onto a level place when possible.

## **Avoid the following locations for installation.**

- Locations exposed to direct sunlight
- Places subject to humidity and with less ventilation
- Places where are extremely hot or cold
- Places subject to strong vibration
- Places subject to dust
- Places subject to oil, steam, and heat (such as kitchens)

## **Do not put articles.**

Do not put articles on this unit.

## **To avoid heat emission**

Do not place this unit on such device as an amplifier that may emit heat. If the unit is installed on a rack, install the unit below the rack where the amplifier is installed so as to avoid heat emission from the amplifier and other audio devices.

## **Notice when this unit is installed in a rack with glass doors**

While the glass doors are closed, do not open the disc tray by pressing the open/close (▲) button of the remote control. Disc tray performance will be blocked, and that may result in a malfunction.

## **Power off this unit when it is not used.**

Depending on the condition of radio waves emitted during television broadcasting, interference fringes may appear on the television monitor, but that is not a malfunction. In such a case, power off the unit. There may also be a case where noises are heard on the radio due to radio wave interference.

## **Dew condensation**

In winter, be careful when carrying this unit from a cold place to a warm place or if the room temperature is suddenly raised by a heater or the like where this unit is installed. The unit interior (operating blocks and lens) will have dew condensation on it. In such a condition, this unit cannot work normally and playback is impossible. This depends on the state of dew condensation, but you will be able to enjoy the music if the unit is left untouched for one to two hours after it has been turned on and the temperature of this unit is maintained at room temperature until the condensation dries.

Even in summer, dew condensation can occur if

this unit is directly exposed to cool air from an air conditioner. In such a case, the installation place should be changed.

## Batteries

### Caution:

Batteries used for remote controller shall not be exposed to excessive heat such as sunshine, fire or the like.

## How to handle discs

- Do not use any deficient disc (with cracks, warp, etc.).
- Do not damage the signal surface of the disc or make it dirty.
- Do not place paper or a sticker on the disc. Such awkward handling can warp the disc and playback may become impossible. In many cases, rental discs carry labels and paste may protrude from under the label. Before use, check that the disc is free from protruding paste or the like.
- Do not play with two discs in a stack.

## How to store discs

- Always put your discs in a case. Store them vertically where high temperature, high humidity, and direct exposure to sunlight are not prevalent. Places with extremely low temperature should also be avoided.
- Read the caution notes carefully that are attached to discs.

## Disc cleaning

- If a disc is dirty from fingerprints or dusty, the sound quality may be lowered. Lightly wipe the disc with soft cloth, from the inside to outer periphery. (Don't wipe it along the circumference.)
- Do not use a volatile chemical such as benzene or thinner. Record spray, anti-static agents, and other such materials cannot be used either.

- Where the disc seems to be very dirty, dip soft cloth in water, wring it well, and remove contaminants. Lastly, remove the moisture with dry cloth.

## Disc in a specific shape

This unit cannot accept discs in specific shapes (heart-shaped, hexagonal, etc.) for playback. Never use such discs as they can cause malfunctions.

## Notice when handling optical digital cables

- Do not fold the cables. For storage, wind each cable to make a coil whose diameter is approx. 15 cm or larger.
- For connection, insert the cable connectors firmly into the terminals of this unit and the other device.
- Use the cables whose each length is 3 m or less.
- When the cable connectors get dusty, wipe the dust away with a dry soft cloth before inserting into the terminals.

## Cleaning

- Usually, wipe the unit with a dry soft cloth. When the dirt is hard to remove, dip soft cloth in detergent diluted 5 or 6 times with water, wring it well, and remove contaminants. Then, remove the moisture with dry cloth.
- Do not use a solvent like alcohol, benzene, thinner, or pesticide because such a substance can damage the exterior. In addition, do not let this unit contact a rubber or plastic form for a long time. That may damage the cabinet surface of the unit.
- When using a chemical cloth for cleaning, read the caution provided with the chemical cloth product.
- Before cleaning, unplug the power cord from the AC outlet.

## Features Of This Unit — 2-channel-specific Super Audio CD/CD Compatible Player

---

### **LxDTM — LuXman original Disc Transport Mechanism —**

This unit is equipped with a robust transport block. The transport block features high rigidity structure SSB (Stabilized Support Block) that doubles as a chassis.

The suede-finish aluminum die-cast disc tray can control vibration and resonance.

QLL (Quiet Linear Loader) is applied to open or close the disc tray quietly and smoothly.

### **Analog circuit**

Amplifier circuit with improved sound quality drives the outputs from the D/A converters.

### **Jitter-reduction function**

This unit is equipped with a circuit to reduce the clock jitter in the system clock.

### **Disc layer switchover function**

By pressing a switch on the main unit or remote control, the CD layer and the HD layer of Hybrid Super Audio CD can be switched over.

### **Zoom function**

When the ZOOM switch is pressed on the remote control during a disc playback, the track number and time information can be zoomed on the display.

### **4 playback modes**

Playback mode can be selected from regular playback, program playback, random playback, and repeat playback.

### **Digital input terminals**

This unit is equipped with a coaxial input terminal and an optical input terminal.

This unit is compatible with SPDIF format signals between 32 kHz and 96 kHz.

It is possible to play back the digital audio signal that is output from another audio device via the circuit of the unit that improves the sound quality.

### **Last memory function**

Built-in flash memory can memorize settings such as digital input, digital output, and Super Audio CD/CD switchover.

### **Dimmer function**

The brightness of display (time information, etc.) can be switched over in 4 steps.

### **Digital output OFF**

The digital audio output can be deactivated to improve the quality of analog audio output.

### **Analog output terminals**

Introduction of an 18 mm pitch RCA terminal with gold plating and a high-grade XLR terminal manufactured by Neutrik allows even a high-performance line cable with large plug to be connected.

### **Remote control (RD-16)**

The remote control is encased in aluminum. All the functions of this unit can be operated on the remote control.





### **Energy-saving design**

This unit has been designed to save energy by reducing standby power consumption to 1 W.

# About Discs This Unit Can Play Back

## Types of discs that can be played

The following marks are printed on disc labels, packages, or CD jackets.

Marks for types of discs this unit can play back		
 SACD <small>SUPER AUDIO CD</small>		
 CD <small>DIGITAL AUDIO</small>	 CD-R <small>DIGITAL AUDIO Recordable</small>	 CD-RW <small>DIGITAL AUDIO ReWritable</small>

This unit can play back 8 cm CDs without using an adapter.

Do not use an adapter for 8 cm CDs.

- CD-R/CD-RW discs that have been written by a recorder or PC (personal computer) may not be played back. (Due to characteristics of discs, scratches, dirt on the lens of the unit, or dew condensation)
- Discs written by a PC may not be played back depending on the application settings or environment. Write the discs in a proper format. (Refer to the distributor of application for details.)
- Time information may not be displayed when an unfinalized CD-R/CD-RW disc is played back.
- Refer to the precautions for discs for details on how to handle CD-R/CD-R discs.

## Super Audio CD

### — 3 types of discs —

#### • Single-layer CD

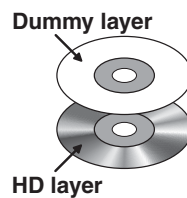

This is a disc which has a single Super Audio CD layer.

#### • Dual-layer CD

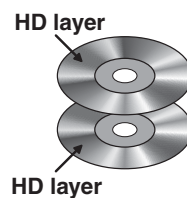

This is a CD which has a dual Super Audio CD layer that supports long-time recording.

#### • Hybrid-layer CD

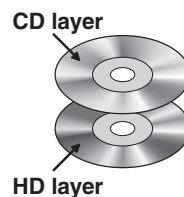

This is a CD which has both a standard CD layer and Super Audio CD layer.

When the disc is played back on a Super Audio CD player, it is possible to enjoy sounds of improved quality on the HD layer. When the disc is played back on an existing CD player, it is possible to play back sounds on the CD layer.

**HD layer: Super Audio CD layer**  
**CD layer: Existing CD layer**

HD layer has the following areas.

- 2-channel stereo area
- Multi-channel area
- Extra data area (For future expansion)

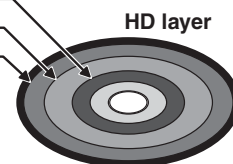



### Comparison of Super Audio CDs with CDs

Item	Super Audio CD	CD
Disc diameter (cm)	12	12
Disc thickness (mm)	1.2	1.2
Coding method	1-bit direct stream digital (DSD)	16-bit linear PCM
Sampling frequency	2.8224 MHz (64 times to CDs)	44.1 kHz
Maximum recordable time	109 minutes for 2ch only. 60 to 70 minutes for 2-channel stereo area + multi-channel area* <sup>1</sup>	74 minutes
Number of channels	2, 3, 3.1, 4, 4.1, 5, 5.1	2
Maximum number of tracks	255	99
Maximum number of indexes	255	99
Playback frequency range	DC to 100 kHz	5 to 20 kHz
Dynamic range* <sup>2</sup>	120 dB or more (Audible frequency range)	96 dB

\*<sup>1</sup> This is the maximum recordable time for a single-layer CD. Depending on the compression rate of DST (Direct Stream Transfer), the maximum recordable time may vary.\*<sup>3</sup>

\*<sup>2</sup> Theoretical value

\*<sup>3</sup> Lossless compression method that applies a variable bit rate for DSD signals. The method has been developed, focused on the DSD signal characteristics.

# Before Use

## Check the accessories.

After unpacking, check if the following accessories are not missing.

- Power cable
- Remote control (RD-16)

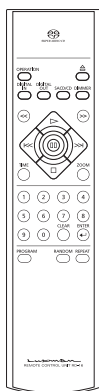

- "AAA" batteries (2 pieces)

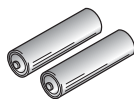

- Safety cautions
- Owner's Manual (This document)

## How to Use Remote Control

### Insert batteries into the remote control.

1. Remove the battery cover on the rear of the remote control.

Put your finger on the battery cover claw and slide the cover downward to remove the cover.

2. Put 2 AAA batteries in the battery case as shown in the illustration on the battery case in consideration of the polarity (+ and -).

3. In the reverse order of battery cover removal, put the battery cover back to the opening of the remote control and slide the cover upward until it clicks.

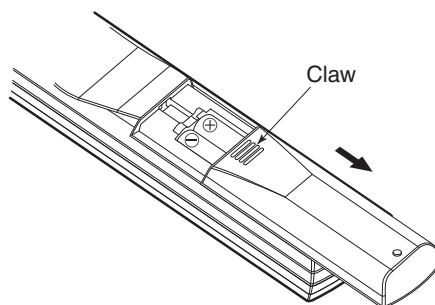

- 
- Do not use a new battery and an old one together.
  - There may be a case in which the voltages are different between two batteries even though their shapes are the same. Do not use the batteries of different types together.
  - If the remote control is not used for a long time (more than 1 month), the batteries shall be removed from the case. If the battery liquid is leaking, wipe away the liquid from the case before inserting new batteries.
-

### Remote control's range

The remote control can be used by pointing at the remote control infrared receiver on the front panel of main unit. The effective distance is approx. 5 m from the main unit and 30 ° on both sides from the control infrared receiver.

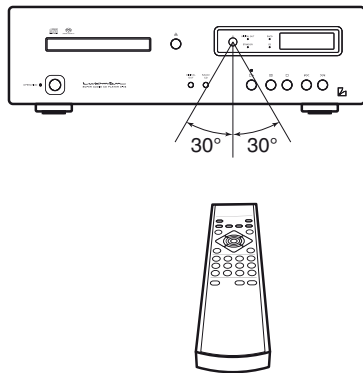

Effective distance: approx. 5 m

---

Do not expose the remote control infrared receiver to direct sunlight or strong light sources. That may cause malfunction.

---

# Names and Functions of Part

## Front side of main unit

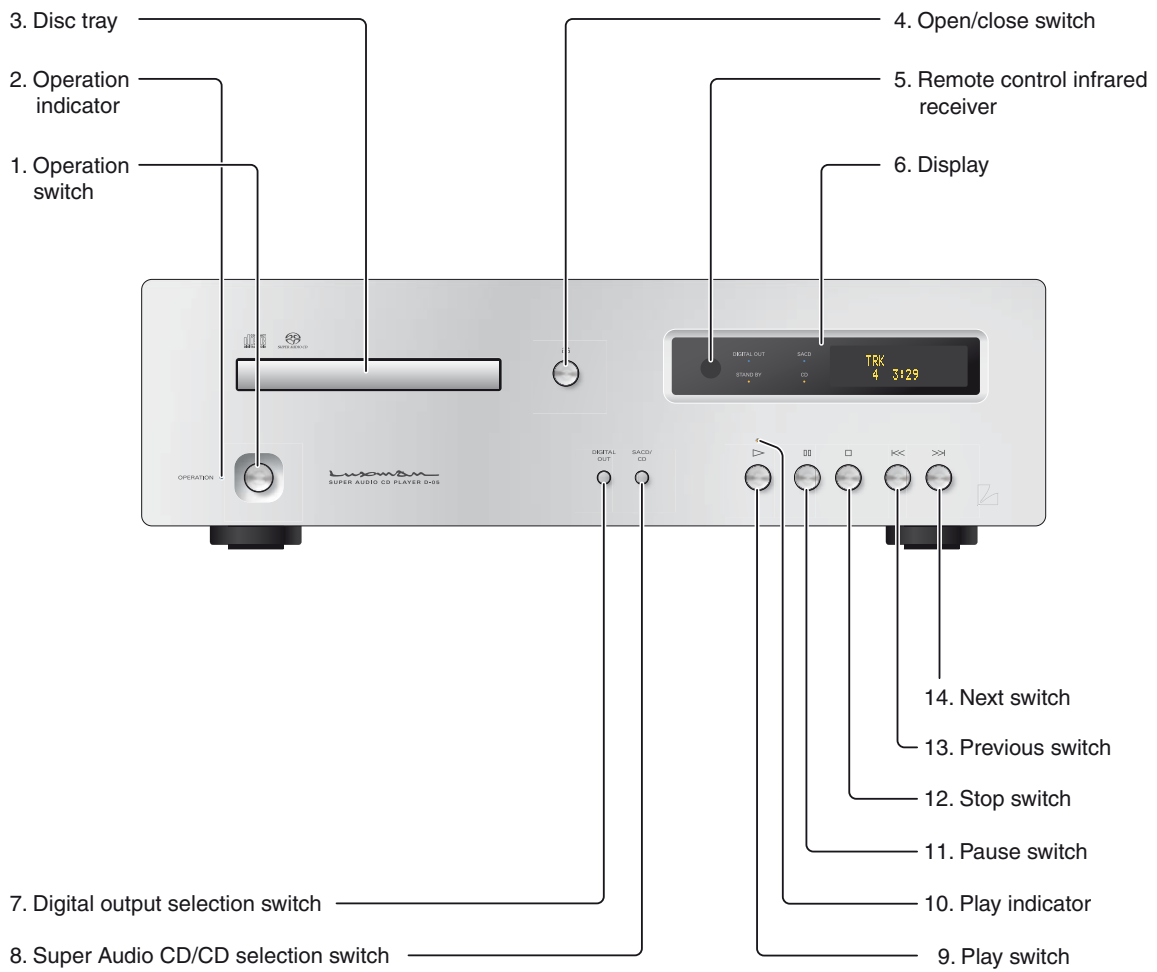

### **1. Operation switch / OPERATION**

Turns this unit to the operating state after turning off the standby indicator at the standby state. Pressing this switch again at the operating state turns the unit to the standby state.

### **2. Operation indicator / OPERATION**

Lights up and shows that the unit is in the operating state when the operation switch is pressed at the standby state.

Pressing the operation switch again in the operating state turns off this indicator and lights up the standby indicator.

### **3. Disc tray**

When inserting or removing a disc, this tray is opened or closed by pressing the open/close switch (▲).

### **4. Open/close switch / (▲)**

This switch is pressed when opening or closing the disc tray.

### **5. Remote control infrared receiver / R**

Receives the infrared signals from the remote control.

### **6. Display**

Displays the operation status of this unit. This display is composed of 4 indicators and display tube.

# Names and Functions of Part

## Front side of main unit

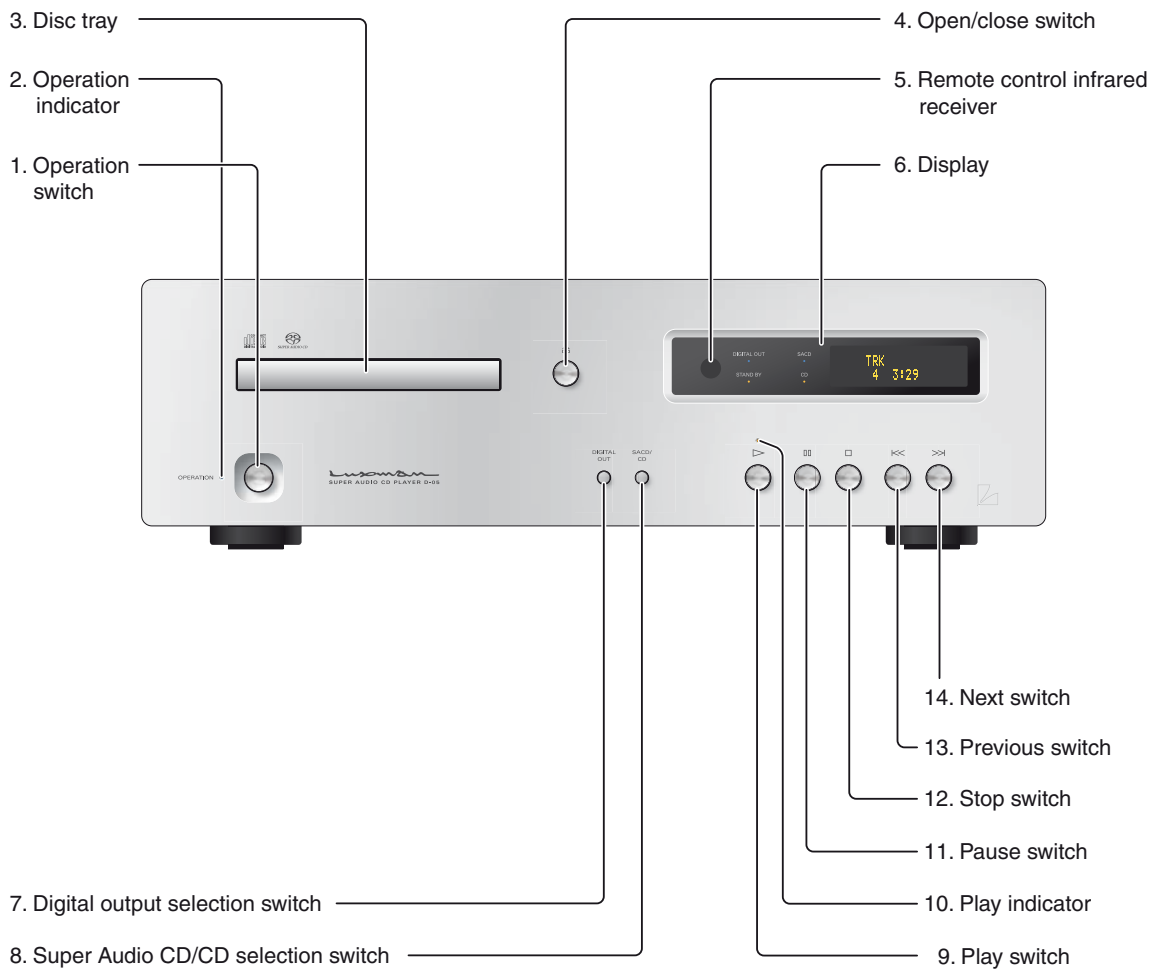

### **7. Digital output selection switch / DIGITAL OUT**

This switch is pressed when turning on or off the digital audio output.

Each time the switch is pressed, the output can be turned on or off.

It is impossible to output the digital audio signal when playing back the HD layer of Super Audio CD.

### **8. Super Audio CD/CD selection switch / SACD/CD**

When playing back a Hybrid Super Audio CD, this switch is pressed to select the playback layer between the HD (or SACD) layer and CD layer.

### **9. Play switch / (▶)**

This switch is pressed to play back a disc.

### **10. Play indicator**

Lights up while a disc is being played back.

Blinks while playback is being paused.

### **11. Pause switch / (⏸)**

When this switch is pressed during playback, the playback stops.

When this switch is pressed again, the playback starts again.

During pause, the play indicator blinks.

### **12. Stop switch / (■)**

This switch is pressed to stop playback.

### **13. Previous switch / (◀◀)**

When this switch is pressed, the playback returns to the beginning of track.

When this switch is pressed twice, the playback returns to the beginning of previous track.

### **14. Next switch / (▶▶)**

When this switch is pressed, the playback jumps to the beginning of next track.

# Names and Functions of Part

## Display

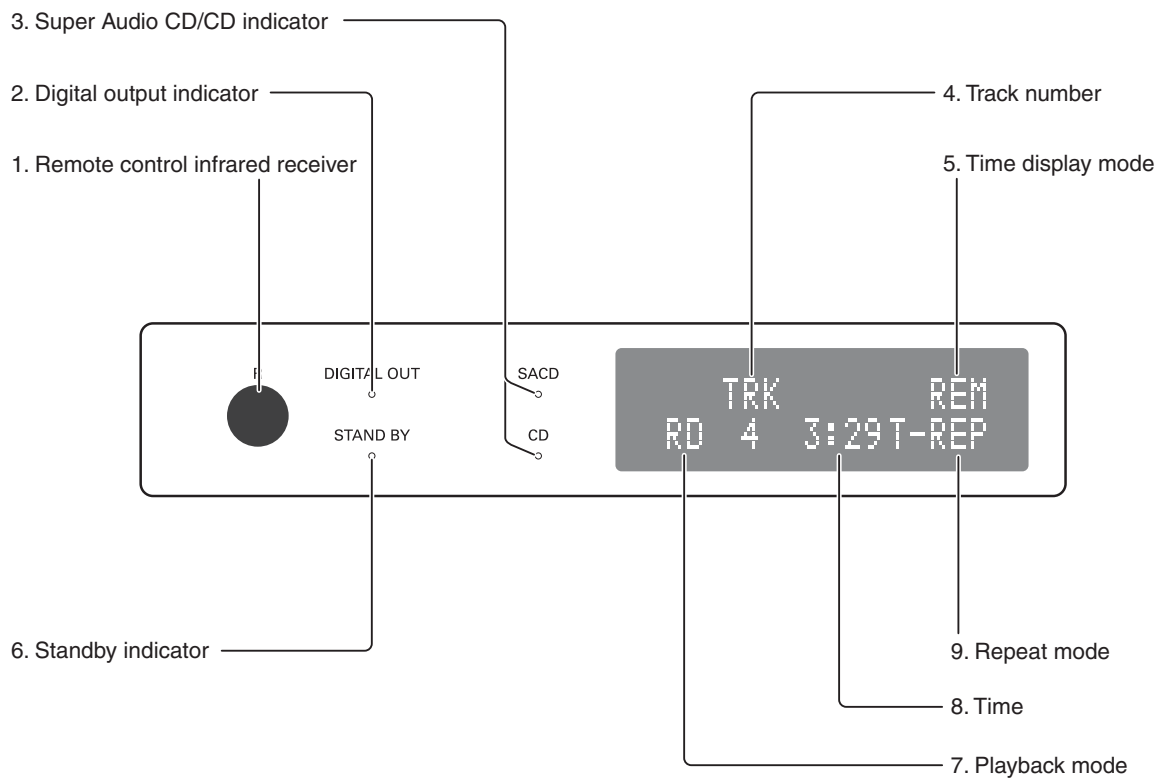



**1. Remote control infrared receiver / R**

Receives the infrared signals from the remote control.

**2. Digital output indicator / DIGITAL OUT**

Lights up when digital audio output is ON.  
This indicator does not light up when playing back the HD layer of Super Audio CD because the digital audio signal cannot be output.

**3. Super Audio CD/CD indicator / SACD/CD**

SACD indicator lights up when playing back the HD (or SACD) layer of Hybrid Super Audio CD  
CD indicator lights up when playing back the CD layer of Hybrid Super Audio CD.

**4. Track number / TRK**

“TRK” is indicated on the upper side, and the track number is indicated on the lower side when these display area shows the track number.

**5. Time display mode**

The display mode of time is displayed. “REM” is displayed when showing the remaining time of current track. “T-REM” is displayed when showing the total remaining time of disc. This display area does not light up when showing the elapsed time of track.

**6. Standby indicator / STAND BY**

Lights up when this unit is in the standby state.

**7. Playback mode**

“RD” is displayed during random playback. “PG” is displayed during program playback.  
This display area does not light up during regular playback.

**8. Time**

Displays the elapsed time of current track, remaining time of current track, or remaining time of disc.  
Time display is switched over according to time display mode.

**9. Repeat mode**

Displays the mode for repeat playback.  
There are two types of repeat playback: track repeat (T-REP) and all repeat (A-REP).

# Names and Functions of Part

## Remote control

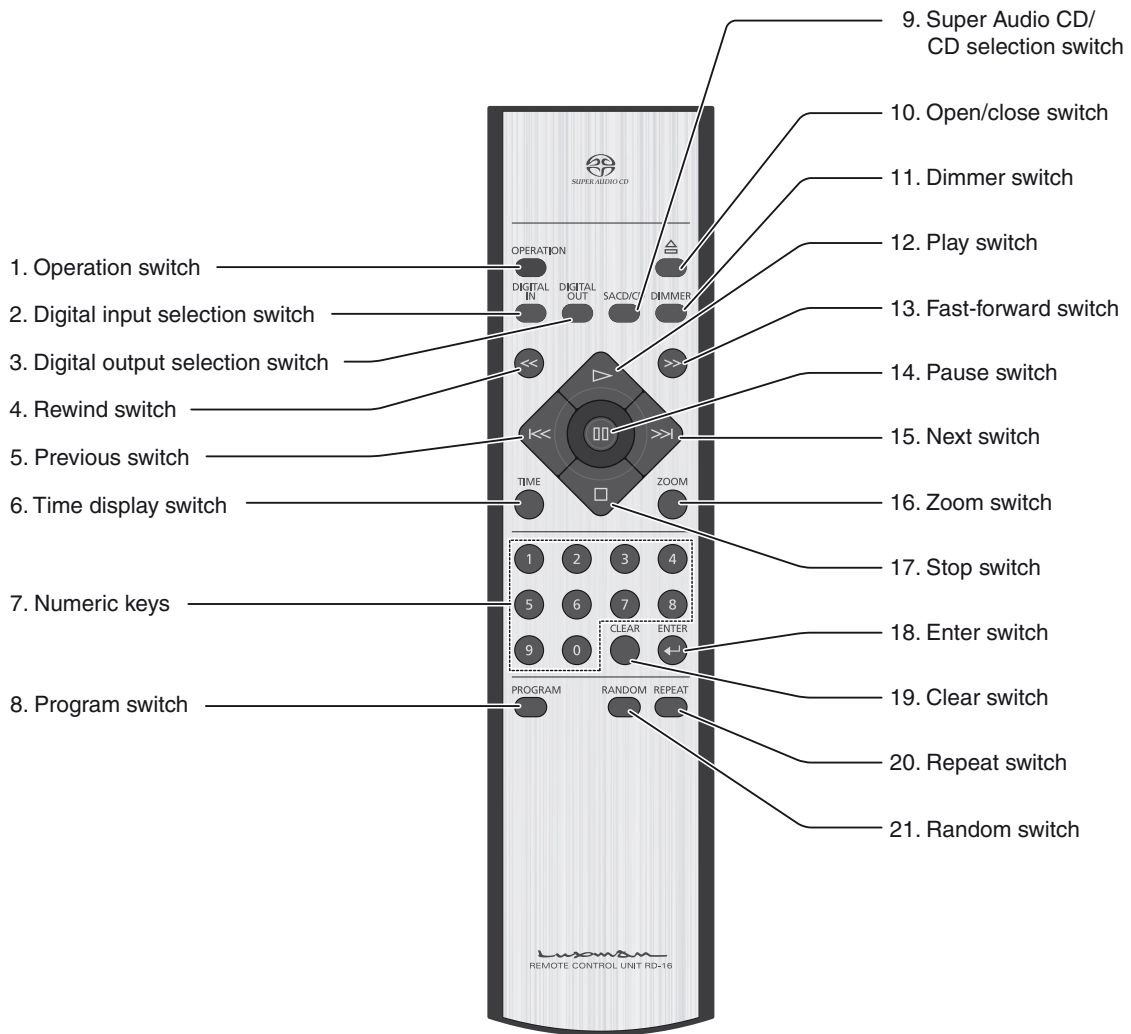

**1. Operation switch / OPERATION**

Turns this unit to the operating state after turning off the standby indicator at the standby state. Pressing this switch again at the operating state turns the unit to the standby state.

**2. Digital input selection switch / DIGITAL IN**

This switch is pressed when using this unit as a D/A converter.

The input source is selected among coaxial input, optical input, or internal player of this unit.

**3. Digital output selection switch / DIGITAL OUT**

This switch is pressed when turning on or off the digital audio output.

Each time the switch is pressed, the output can be turned on or off.

The digital audio signal cannot be output when playing back the HD layer of Super Audio CD.

**4. Rewind switch / (◀◀)**

When this switch is played during playback, audio is rewind.

**5. Previous switch / (◀◀)**

When this switch is pressed, the playback returns to the beginning of track.

When this switch is pressed twice, the playback returns to the beginning of previous track.

**6. Time display switch / TIME**

Switches the time display.

Switches the elapsed time of current track, remaining time of current track, or remaining time of disc.

**7. Numeric keys /**

**1, 2, 3, 4, 5, 6, 7, 8, 9, 0**

These keys are pressed to specify the track numbers for direct search or program.

**8. Program switch / PROGRAM**

Programs the track numbers to play back in a desired order.

# Names and Functions of Part

## Remote control

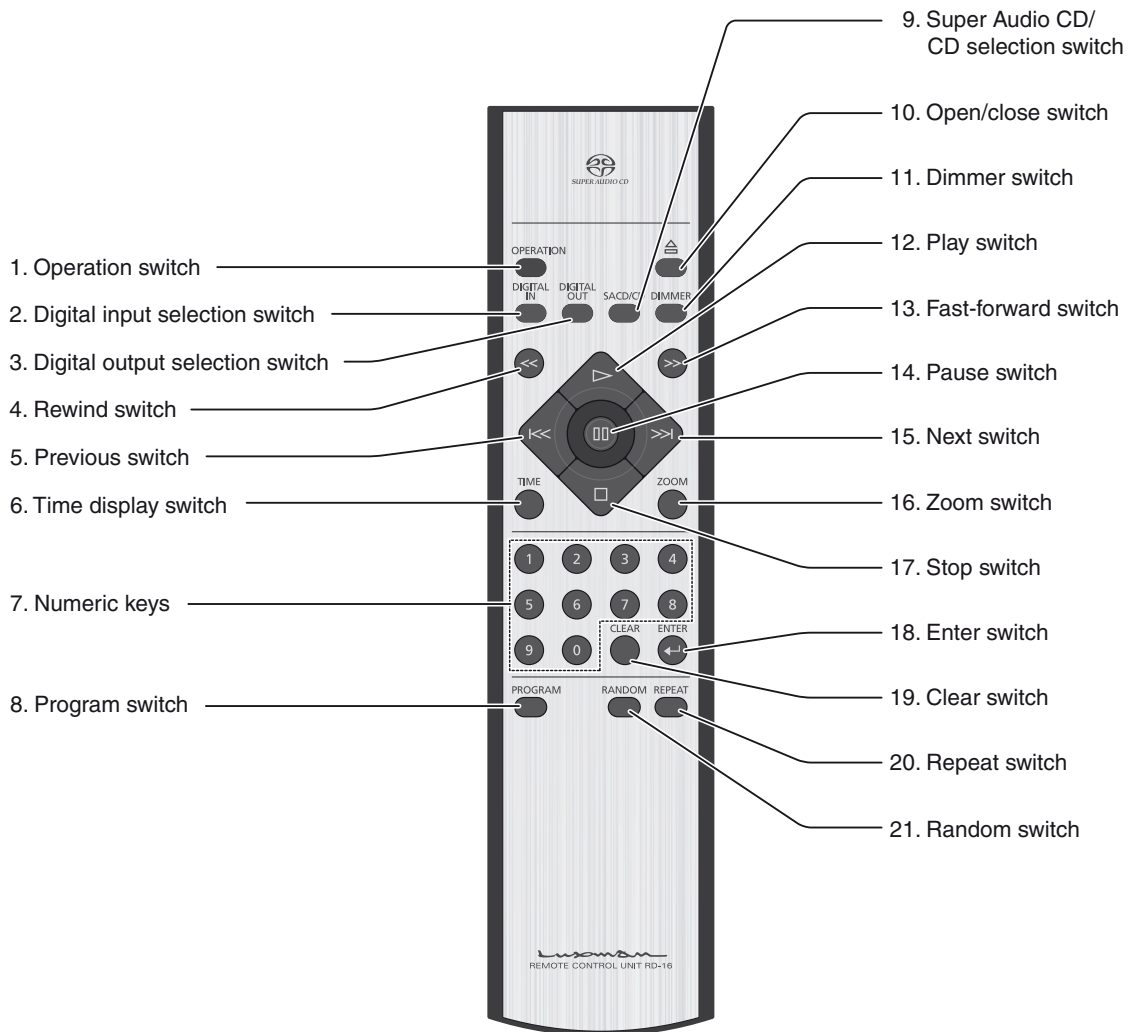

### **9. Super Audio CD/CD selection switch / SACD/CD**

When playing back a Hybrid Super Audio CD, this switch is pressed to switch over the playback layer between the HD (or SACD) layer and CD layer.

### **10. Open/close switch / (▲)**

This switch is pressed when opening or closing the disc tray.

### **11. Dimmer switch / DIMMER**

Adjusts the brightness of the main unit display. The brightness can be adjusted in 4 steps from no light to normal lighting.

### **12. Play switch / (▶)**

This switch is pressed to play back a disc.

### **13. Fast-forward switch / (▶▶)**

When this switch is played during playback, audio is fast-forwarded.

### **14. Pause switch / (||)**

When this switch is pressed during playback, the playback stops.

When this switch is pressed again, the playback starts again.

During pause, the play indicator blinks.

### **15. Next switch / (▶▶)**

When this switch is pressed, the playback jumps to the beginning of next track.

### **16. Zoom switch / ZOOM**

When this switch is pressed during playback, the track number and time are zoomed on the display.

### **17. Stop switch / (■)**

This switch is pressed to stop playback.

### **18. Enter switch / ENTER**

This switch is pressed to execute the set or selected items.

### **19. Clear switch / CLEAR**

This switch is pressed to cancel the program settings.

### **20. Repeat switch / REPEAT**

This switch is pressed to perform repeat playback.

There are two types of repeat playback: track repeat (T-REP) and all repeat (A-REP).

### **21. Random switch / RANDOM**

This switch is pressed to perform random playback.

# Names and Functions of Part

## Rear side of main unit

1. Analog audio output terminals  
(Unbalanced)

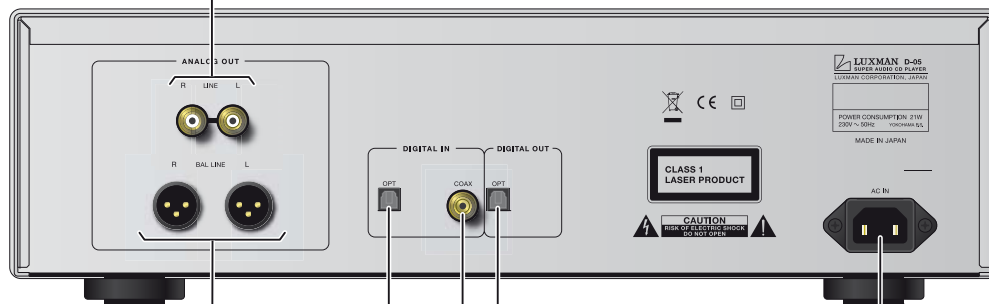

2. Analog audio output terminals  
(Balanced)

3. Optical digital input terminal

4. Coaxial digital input terminal

6. Power cable terminal

5. Optical digital output terminal

### **1. Analog audio output terminals (Unbalanced) / LINE**

Connect these terminals to an unbalanced input of such device as a preamplifier with a pin-plug cable.

### **2. Analog audio output terminals (Balanced) / BAL LINE**

Connect these terminals to a balanced input of an output device such device as a preamplifier with a balanced cable.

The following are the polarities of analog audio output terminals.

1. GROUND
2. COLD (-)
3. HOT (+)

### **3. Optical digital input terminal / OPT**

When using this unit as a D/A converter, connect this terminal to such device as a recorder that has a digital output terminal using an optical digital cable.

The following sampling frequencies are supported: 32 kHz, 44.1 kHz, 48 kHz, 88.2 kHz, 96 kHz. This terminal has a shutter. Direct the cable connector correctly when inserting the cable into the terminal. If the cable connector is inserted forcibly with the wrong direction, the terminal may be deformed, and the shutter may not be able to close even after cable disconnection.

### **4. Coaxial digital input terminal / COAX**

When using this unit as a D/A converter, connect this terminal to such device as a recorder that has a digital output terminal using a coaxial digital cable.

The following sampling frequencies are supported: 32 kHz, 44.1 kHz, 48 kHz, 88.2 kHz, 96 kHz

### **5. Optical digital output terminal / OPT**

Connect this terminal to such device as an amplifier that has a digital input terminal using an optical digital cable. It is impossible to output the digital audio signal when playing back the HD layer of Super Audio CD.

This terminal has a shutter. Direct the cable connector correctly when inserting the cable into the terminal. If the cable connector is inserted forcibly with the wrong direction, the terminal may be deformed, and the shutter may not be able to close even after cable disconnection.

### **6. Power cable terminal / AC IN**

Connect the accessory power cable to supply the power from the AC outlet on the wall.

# Connections

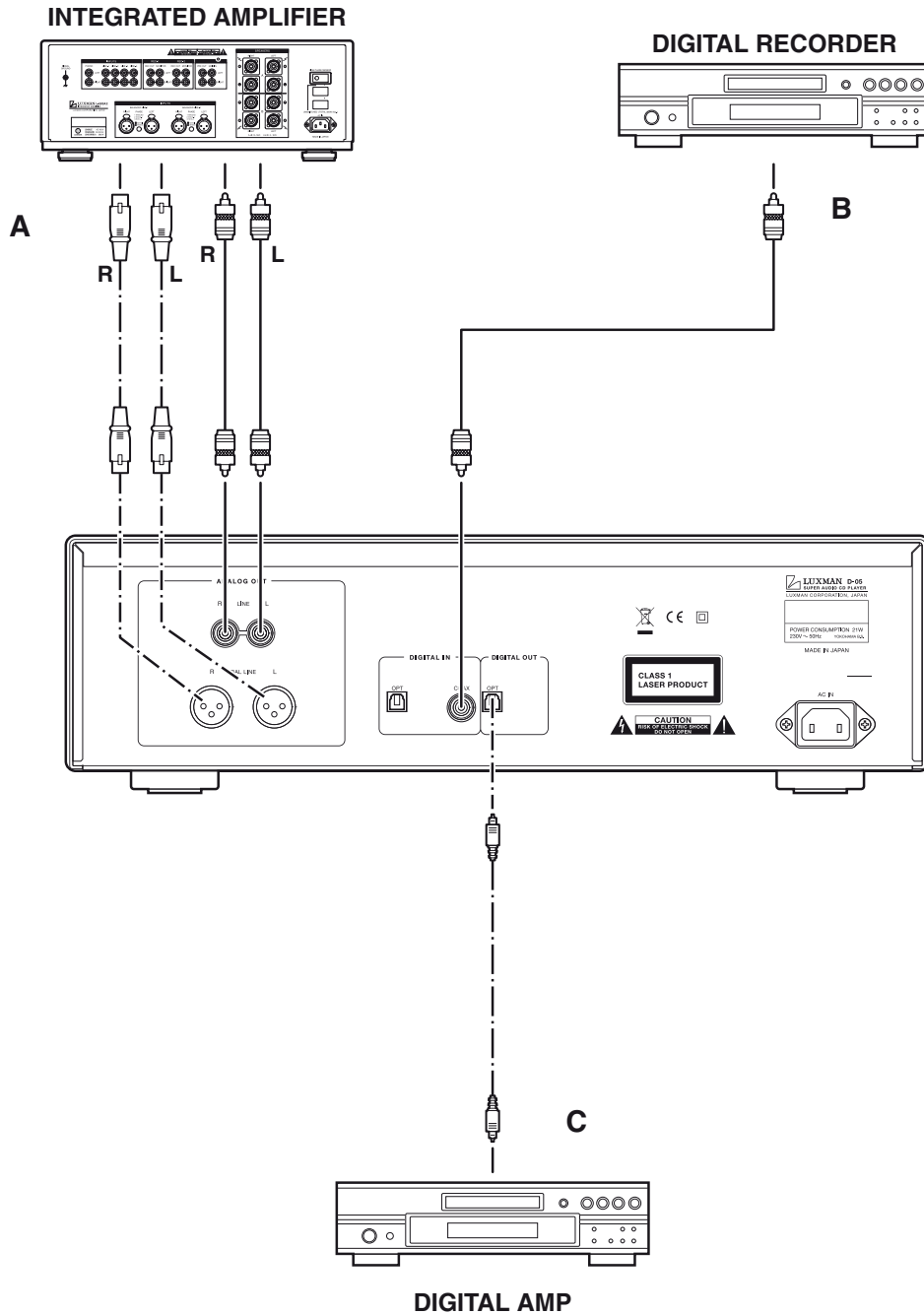



## Before Connecting

1. **Connect the accessory power cable to an AC outlet.**

## Connections

2. **Connect the audio cables.  
(Refer to “A” in the illustration on the previous page.)**

When applying unbalanced connections, connect the terminals to an unbalanced input of such device as a preamplifier with a pin-plug cable. When applying balanced connections, connect the terminals to a balanced input of such device as a preamplifier with a pin-plug cable.

At this moment, exercise extra care not to conduct wrong connection between the right and left channels. If the right and left channels are connected reversely, the localization of sound images is deteriorated, thus failing in normal stereo playback.

If pin-plug cables are used, inadequate connection of the grounding of the cables may generate noises including hum, resulting in an adverse S/N ratio. Surely insert the connection plug.

---

Before connecting devices or changing the configuration, be sure to power off the unit, and disconnect the power cable from the AC inlet (power cable terminal/AC IN) of the unit.

---

3. **When using this unit as a D/A converter (Refer to “B” in the illustration on the previous page.)**

When connecting this terminal to such device as a recorder that has a digital output terminal, use an optical digital cable or digital cable.

---

This terminal has a shutter.

Direct the cable connector correctly when inserting the cable into the terminal.

If the cable connector is inserted forcibly with the wrong direction, the terminal may be deformed, and the shutter may not be able to close even after cable disconnection.

---

Upper side



The optical terminals are directed as illustrated.

Lower side

4. **When connecting to such device as an amplifier that has a digital input terminal  
(Refer to “C” in the illustration on the previous page.)**

Connect this terminal to such device as an amplifier or recorder that has a digital input terminal using an optical digital cable (C).

It is impossible to output the digital audio signal when playing back the HD layer of Super Audio CD.

---

This terminal has a shutter.

Direct the cable connector correctly when inserting the cable into the terminal.

If the cable connector is inserted forcibly with the wrong direction, the terminal may be deformed, and the shutter may not be able to close even after cable disconnection.

---

# How to Play Back Discs

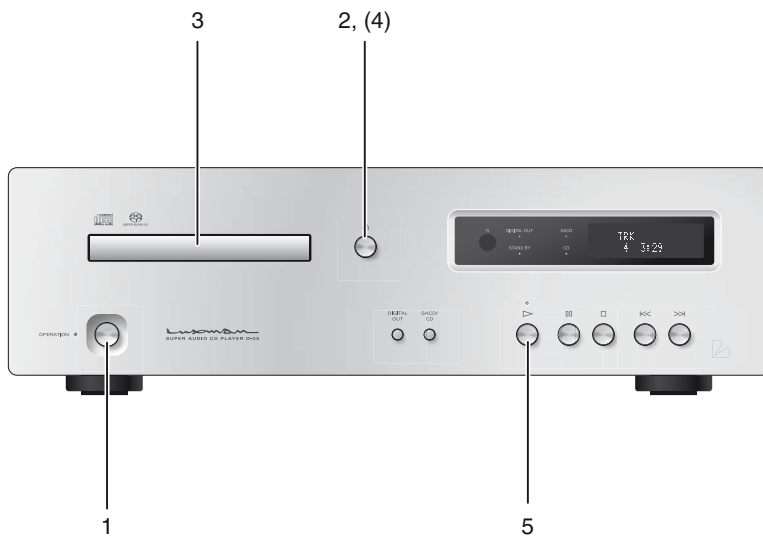
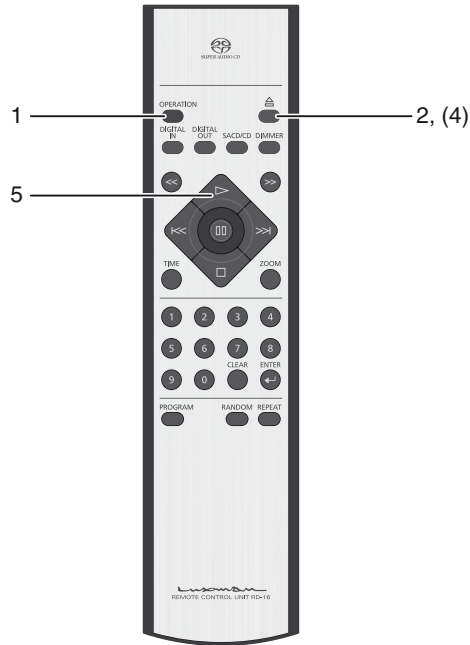

## Play back a disc.



### 1. Press the OPERATION switch.

"-OPERATION-" appears on the display. When "-OPERATION-" disappears, the unit becomes operable.

### 2. Press the open/close (▲) switch.

The disc tray opens.

### 3. Put the disc on the disc tray according to the guide on the tray.

### 4. Press the open/close (▲) switch.

The disc tray closes and the disc is loaded.

To start playback more quickly, press the play (▶) switch without pressing the open/close (▲) switch.

Or select a track by pressing a numeric key without pressing the open/close (▲) switch, and press the ENTER or play (▶) switch.

Operation switches and numeric keys are not functional until a disc is loaded, disc type is displayed, and then the number of tracks and total recording time are displayed. It is possible to shorten the time until playback starts by specifying the next operation in advance. (Compared to dedicated CD players, it may take a little longer time until the disc is loaded and playback starts.)

### 5. Press the play (▶) switch.

# Stop/Pause the Playback

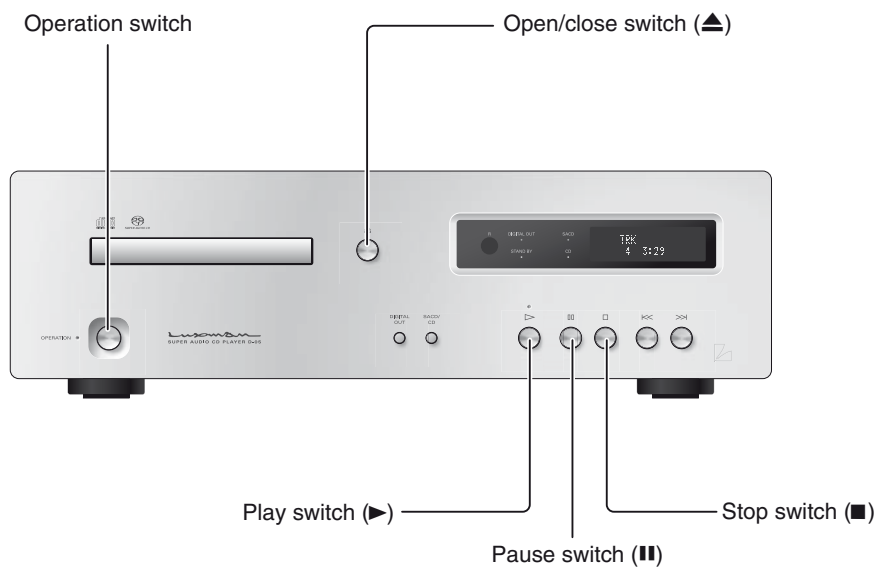
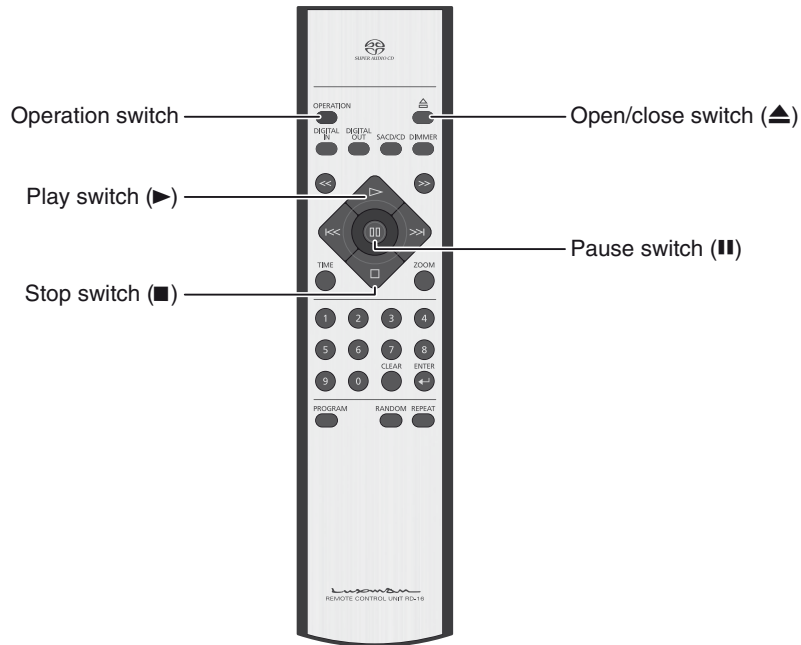

### Pause the playback of a disc.



#### Pause playback.

**1. Press the pause (II) switch.**

During pause, the play indicator blinks.

#### Resume the regular playback.

**2. During pause, press the play (▶) or pause (II) switch.**

#### Stop the playback.

During playback, press the stop (■) switch.

#### Eject a disc.

**Press the open/close (▲) switch.**

The disc tray opens.

#### Power off the unit. (Turn the unit to the standby state.)

**Press the OPERATION switch.**

"-OPERATION-" appears on the display, and the STANDBY indicator lights up.

To power off the unit completely, it is required to disconnect the power plug from the AC wall outlet.

# Skip/Fast-forward/Rewind

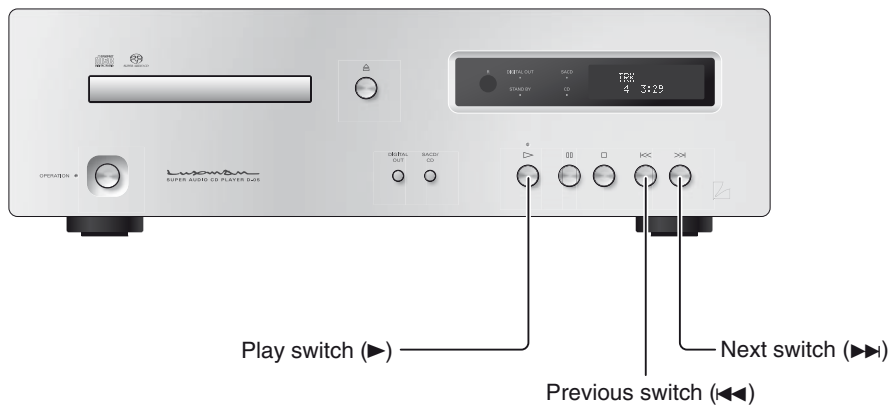
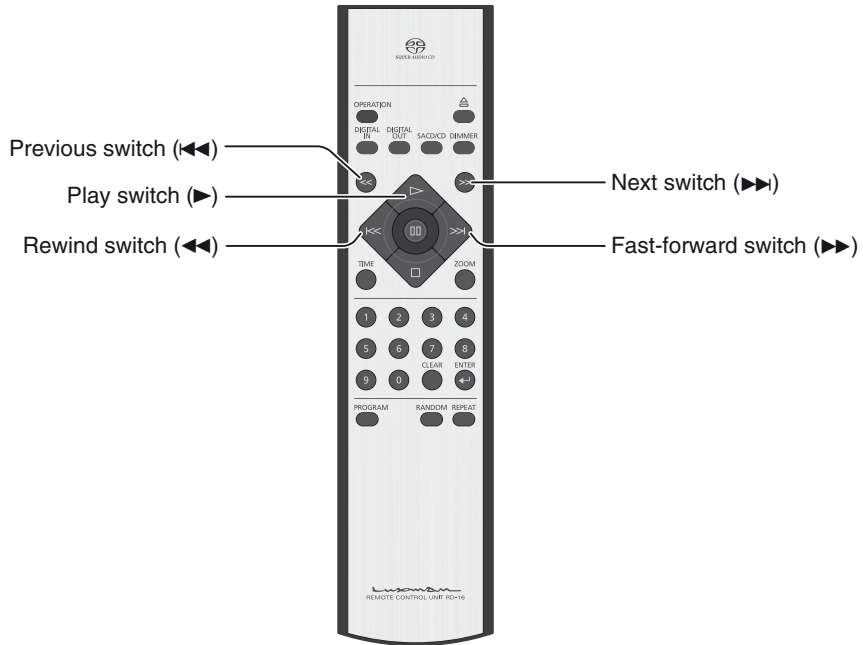

### Skips to the desired track. (Skip playback)



#### Skips (Skip playback) Skip to the track to play back.

To skip to the track to play back, press the next switch (▶▶) repeatedly until the desired track is displayed.

#### Go back to the track to play back.

To go back to the track to play back, press the previous switch (◀◀) repeatedly until the desired track is displayed.

When this switch is pressed once, the playback returns to the beginning of current track.  
When this switch is pressed twice, the playback returns to the beginning of previous track.

### Fast-forward/rewind the playback. (Scan)



#### Fast-forward the playback.

##### 1. During playback, press the fast-forward (▶▶) switch.

Each time the switch is pressed, the fast-forward speed can be changed in 4 steps.

">>1, >>2, >>3, >>4" appears on the display to indicate the fast-forward state and speed.

##### 2. To resume the regular playback, press the play (▶) switch.

#### Rewind the playback.

##### 1. During playback, press the rewind (◀◀) switch.

Each time the switch is pressed, the rewind speed can be changed in 4 steps.

"<<1, <<2, <<3, <<4" appears on the display to indicate the rewind state and speed.

##### 2. To resume the regular playback, press the play (▶) switch.

---

When a set of tracks are composed of two or more Super Audio CDs, the first track may not be Track 1.

---

# Direct Search

Numeric keys





## Specify the desired track for playback



### 1. Enter a track number by pressing numeric keys.

For example, when selecting the 15th track, press the "1" key, and then "5".

### 2. Press the ENTER or play switch.

Playback is started automatically even without pressing the ENTER key after the elapse of approx. 4 seconds.

The maximum number of tracks is 255 for a Super Audio CD, and it may take longer time to enter a 3-digit track number. For this reason, approx 4 seconds are given to Super Audio CDs before auto jump.

# Repeat Playback



Repeat switch

**Repeat the playback.  
(Repeat playback)**



There are two types of repeat playback: track repeat (T-REP) and all repeat (A-REP).

**Track repeat (T-REP)**

- 1. During playback, press the REPEAT switch once.**
- 2. “T-REP” appears on the display to indicate track repeat.**
- 3. When the REPEAT switch is pressed twice, track repeat is canceled.**

Track repeat is also canceled when the disc is stopped.

**All repeat (A-REP)**

- 1. During playback, press the REPEAT switch twice.**
- 2. “A-REP” appears on the display to indicate all repeat.**
- 3. When this switch is pressed once again, all repeat is canceled.**  
All repeat is also canceled when the disc is stopped.

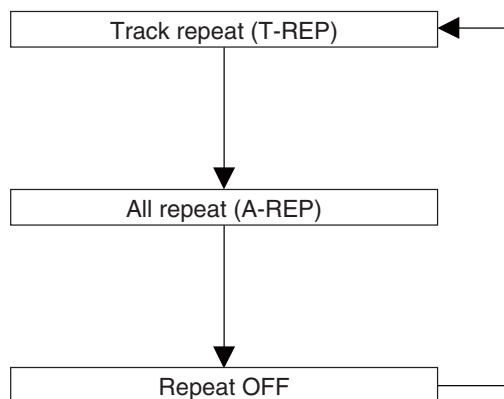

# Program Playback

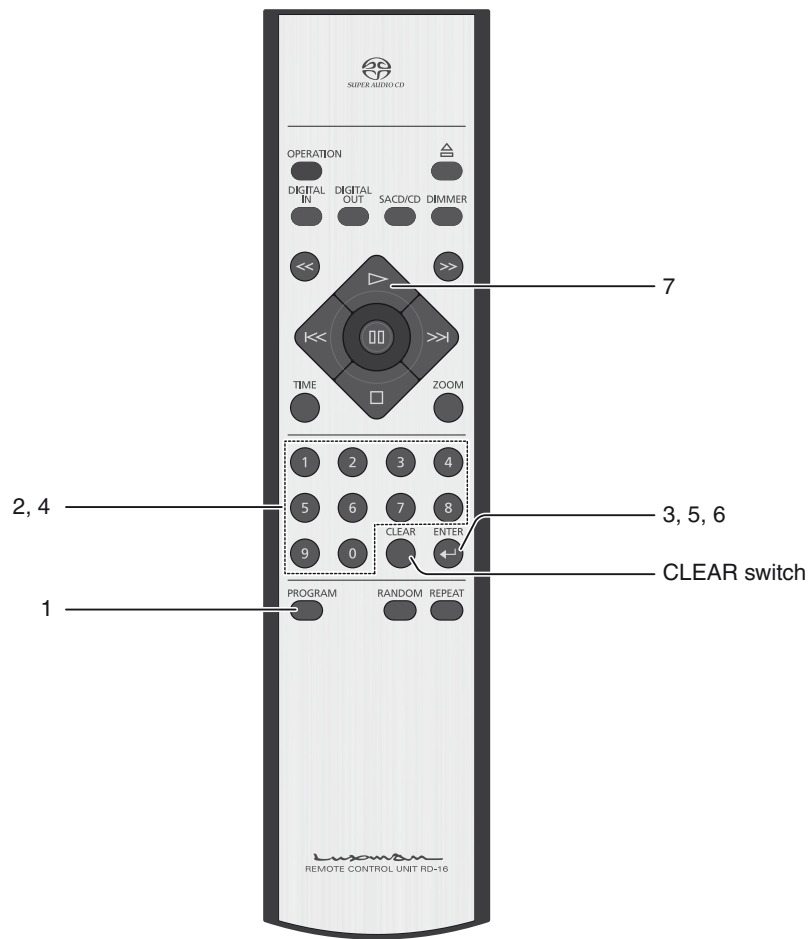

**Play back the tracks in a programmed order.  
(Program playback)**

Remote control

**It is possible to program up to 24 tracks in the desired order.**

**1. During stop, press the PROGRAM switch.**

The following appears on the display.

	T-TIME
PG 00	00:00

**2. Enter a desired track number by pressing numeric keys of the remote control.**

For example, when selecting the 5th track, press the "5" key.

PG 01	5
-------	---

**3. Press the ENTER switch.**

The order of the track is determined, and then track number and total time appear on the display.

	T-TIME
PG 01	01:28

**4. Enter the track number to program next.**

For example, when selecting the 15th track, press the "1" key, and then "5".

PG 02	15
-------	----

**5. Press the ENTER switch.**

The order of the track is determined, and then track number and total time appear on the display.

	T-TIME
PG 02	02:01

# Program Playback

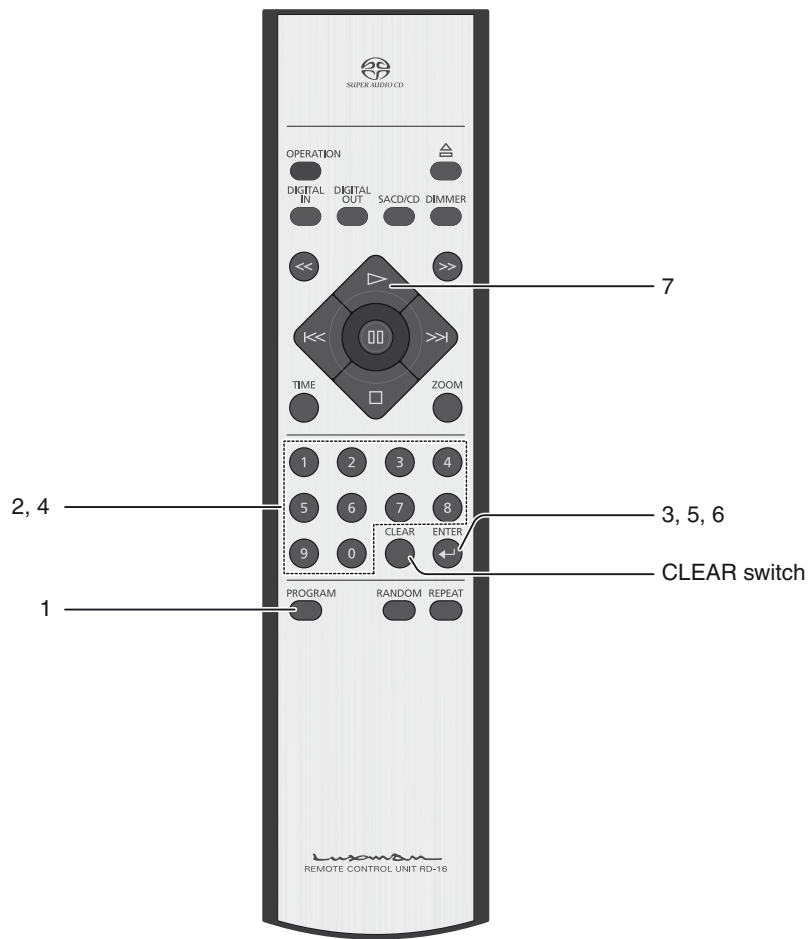

## 6. Press the ENTER switch.

Program the desired tracks by repeating Step 2 and 3.

## 7. Press the play (▶) switch.

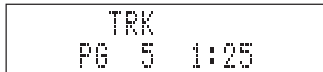

- When pressing the CLEAR switch during stop, all the program is deleted.
- When pressing the PROGRAM switch, and then the CLEAR switch during stop, the tracks will be deleted in the reverse order.
- It is impossible to program pause.
- When pressing the REPEAT switch during program playback, all repeat is performed in the programmed order.
- Track repeat is impossible during program playback.
- When pressing the next (▶▶) switch during program playback, the playback jumps to the next track in the programmed order.
- To perform the program playback again, press the PROGRAM switch during stop, and then the play (▶) switch.

### Procedure

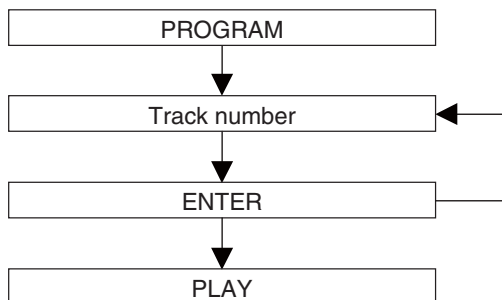

# Random Playback



RANDOM switch



**Play back the tracks in a random order.  
(Random playback)**



**Each track is randomly selected from all the tracks to be played back once.**

- 1. Press the RANDOM switch.**
- 2. "RD" appears on the display to indicate random playback. The playback stops automatically after all the tracks are played back.**

Random playback stops when a disc is stopped or the RANDOM switch is pressed once again.

When pressing the next (▶▶) switch during random playback, the next track is randomly selected to be played back.

When pressing the previous (◀◀) switch, the playback returns to the beginning of current track.

# Disc Information/Zoom

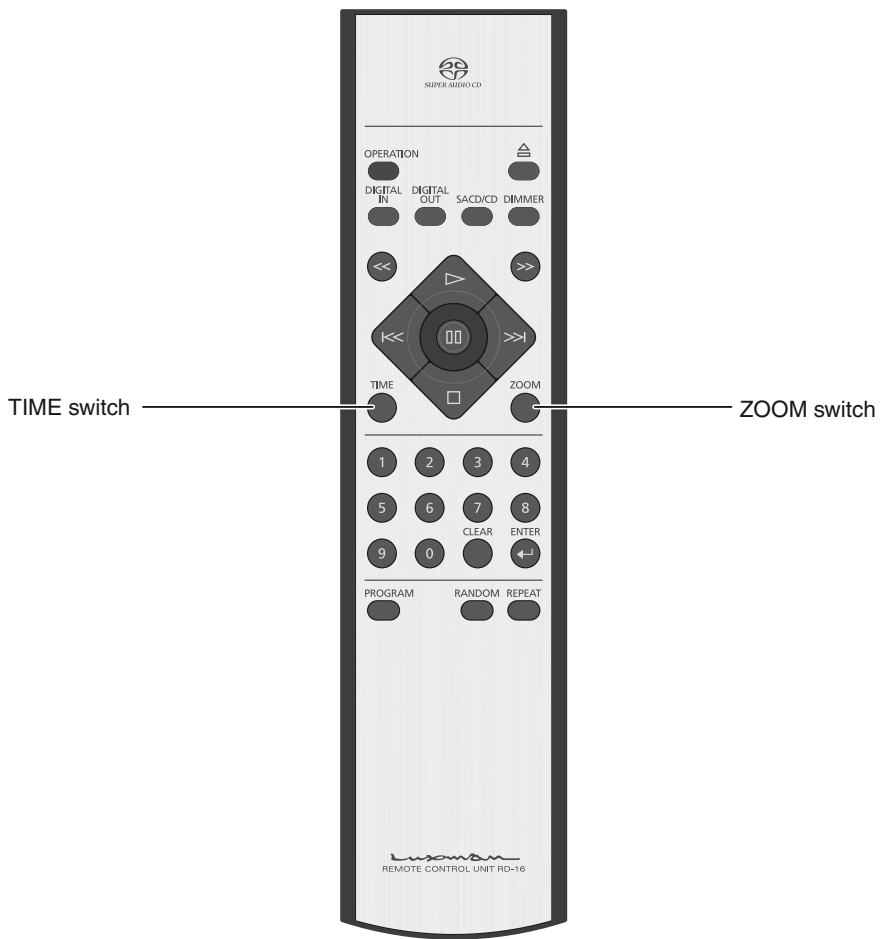

## Disc information

Remote control

### The time display can be switched over during playback.

Each time the TIME switch is pressed during playback, the display changes as follows.

1. **The current track number and the elapsed time of the track (In the default setting):**  
“TRK” will appear on the display.
2. **The current track number and the remaining time of the track (Remain):**  
“TRK” and “REM” will appear on the display.
3. **The total remaining time of the disc (Total remain):**  
“T-REM” will appear on the display.

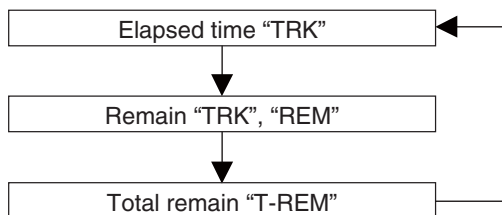

## Zoom

Remote control

### The display can be zoomed.

1. **When pressing the ZOOM switch on the remote control during playback, the track number and time are zoomed.**

It is impossible to zoom other display areas.

2. **When pressing the ZOOM switch once again, the display returns to the normal state.**

Normal display

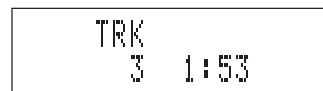

Zoomed display

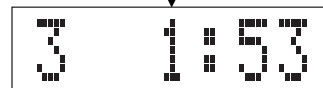

# Detailed Settings

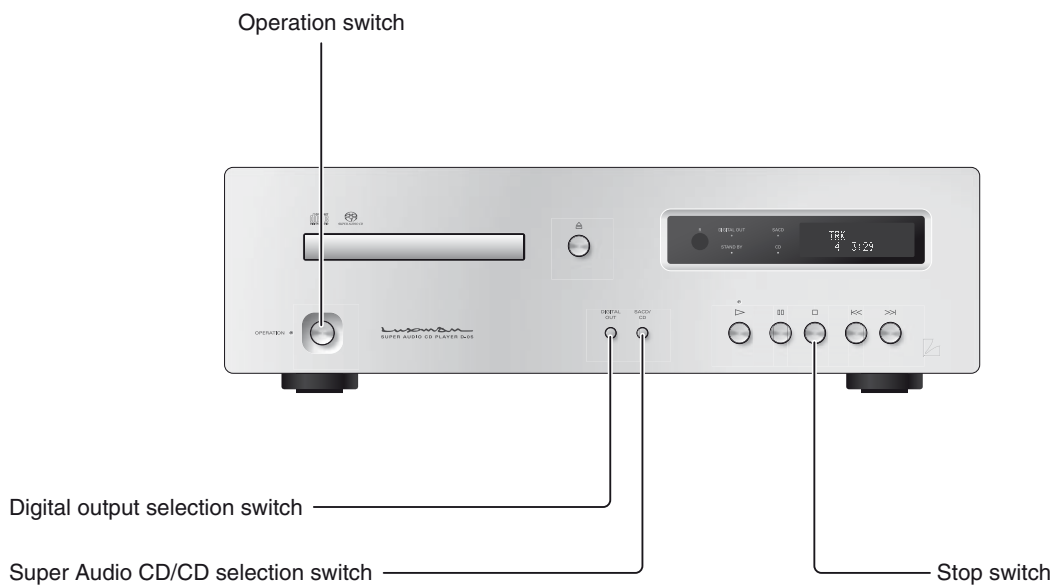
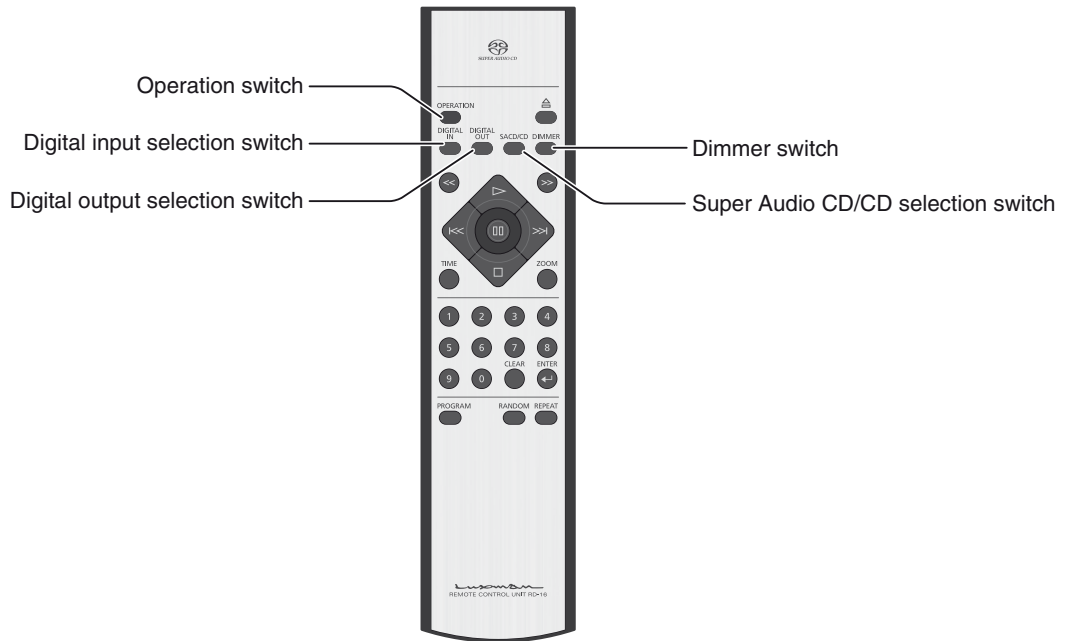

## Dimmer switch / DIMMER



The brightness of the main unit display can be adjusted. The brightness can be adjusted in 4 steps from no light to normal lighting. It is impossible to change the brightness of LED such as “SACD” and “CD”.

Each time the DIMMER switch is pressed, the display changes as follows. Normal light → Darker → Significantly darker → No light → Normal light → ...  
Selection of no light displays “DISPLAY OFF” for 1 second and the sign turns off.

## Super Audio CD/CD selection switch/ SACD/CD



When playing back a Hybrid Super Audio CD, this switch is pressed to switch over the playback layer between the HD (or SACD) layer and CD layer.

### 1. During stop, press the SACD/CD switch.

Each time this switch is pressed, the playback layer is switched over between the HD (or SACD) layer and CD layer.

### 2. When the HD layer is selected, the Super Audio CD (SACD) indicator lights up on the main unit display.

When the CD layer is selected, the CD indicator lights up on the main unit display.

- 
- This setting is activated even when another Hybrid Super Audio CD is loaded.
  - When a single-layer CD or dual-layer CD is loaded, the HD layer is automatically selected.
  - This unit does not support SACD multi-channel areas.
-

# Detailed Settings

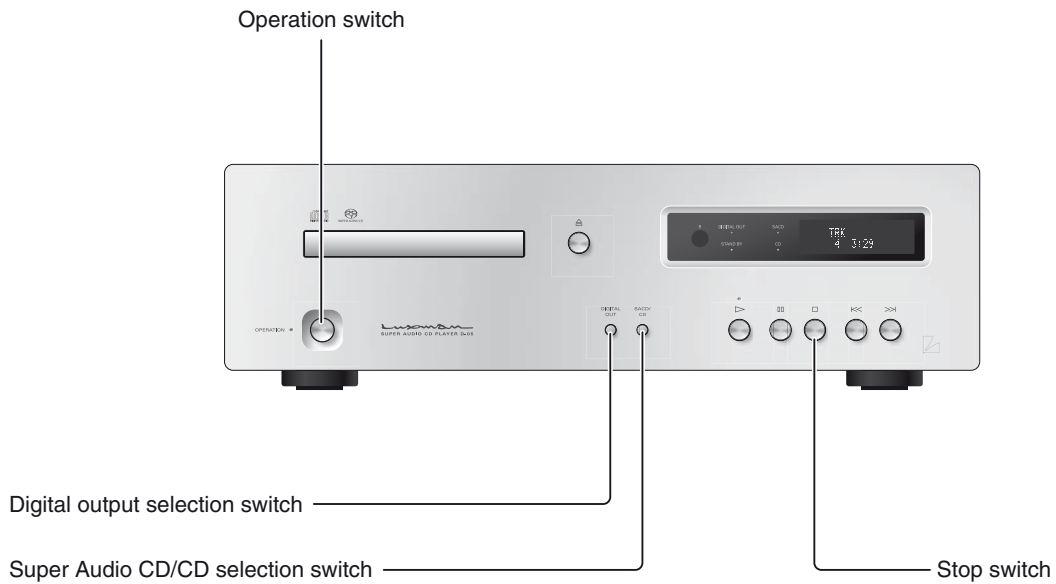
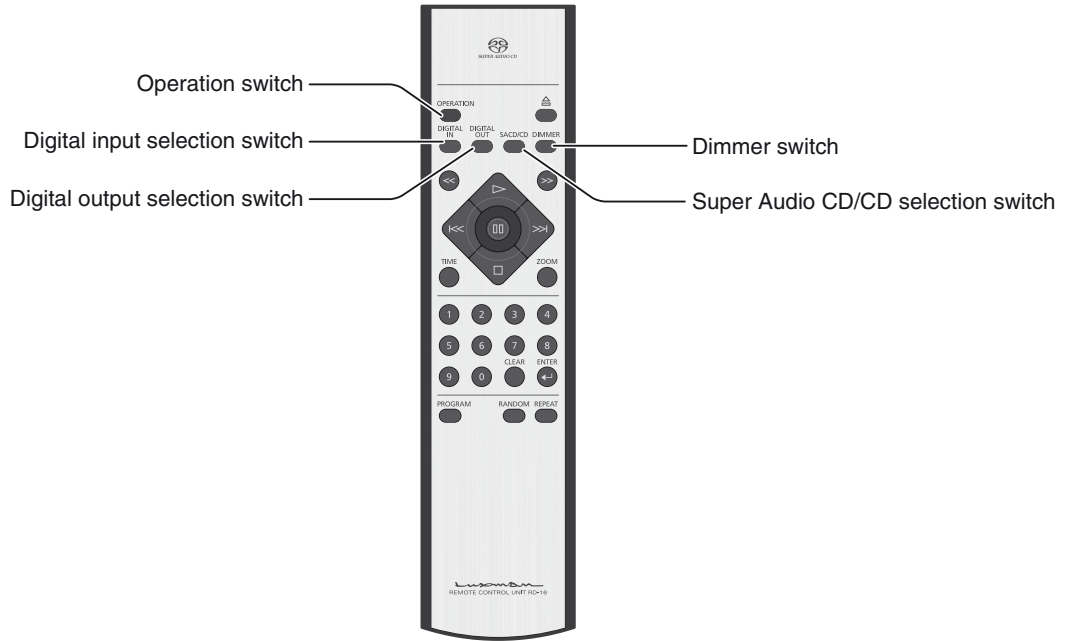

## Digital input selection switch / DIGITAL IN



This switch is pressed when using this unit as a D/A converter.

### 1. Each time the DIGITAL IN switch is pressed, the display changes as follows. COAXIAL → OPTICAL → INTERNAL (Internal player)

The following sampling frequencies are supported for digital inputs: 32 kHz, 44.1 kHz, 48 kHz, 88.2 kHz, 96 kHz

### 2. The selected input type and sampling frequencies appear on the main unit display.

- The display indicates the content of sampling frequency data included in the channel status which IEC60958-3 (Digital audio interface - Part 3: Consumer applications) specifies.

Some output devices may output channel status data whose content is different from the actual sampling frequency. In such a case, the contents of channel status data are indicated on the display instead of the actual sampling frequency.

Or some devices or sources may output the sampling frequency data which means "Not to indicate the sampling frequency". In such a case, "UNKOWN" appears on the display.

- There may be a case where the display indicates "LOCK" shortly, and then "UNLOCK". (The reverse case is also possible.)

That is because the former state (LOCK/UNLOCK) is indicated for approx. 0.5 seconds since an input signal is changed until the circuit gets stable.

## Digital output selection switch / DIGITAL OUT



This switch is pressed when turn on or off the digital audio output. Each time the switch is pressed, the output can be turned on or off.

It is impossible to output the digital audio signal when playing back the HD layer of Super Audio CD.

At this time, the DIGITAL OUT indicator turns off.

It is possible to turn on or off the digital audio output when playing back the CD layer of Hybrid Super Audio CD.

# Detailed Settings

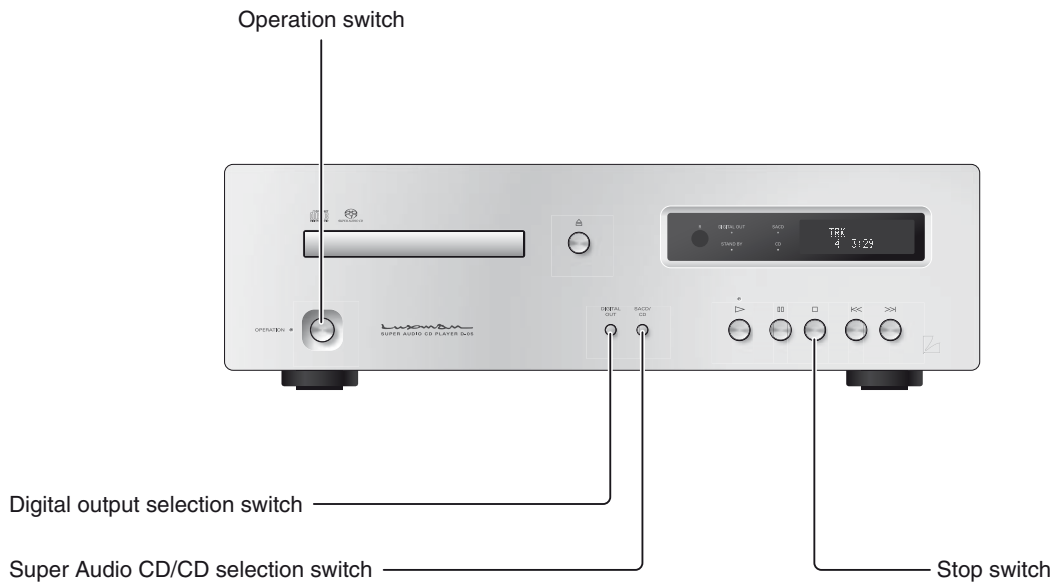
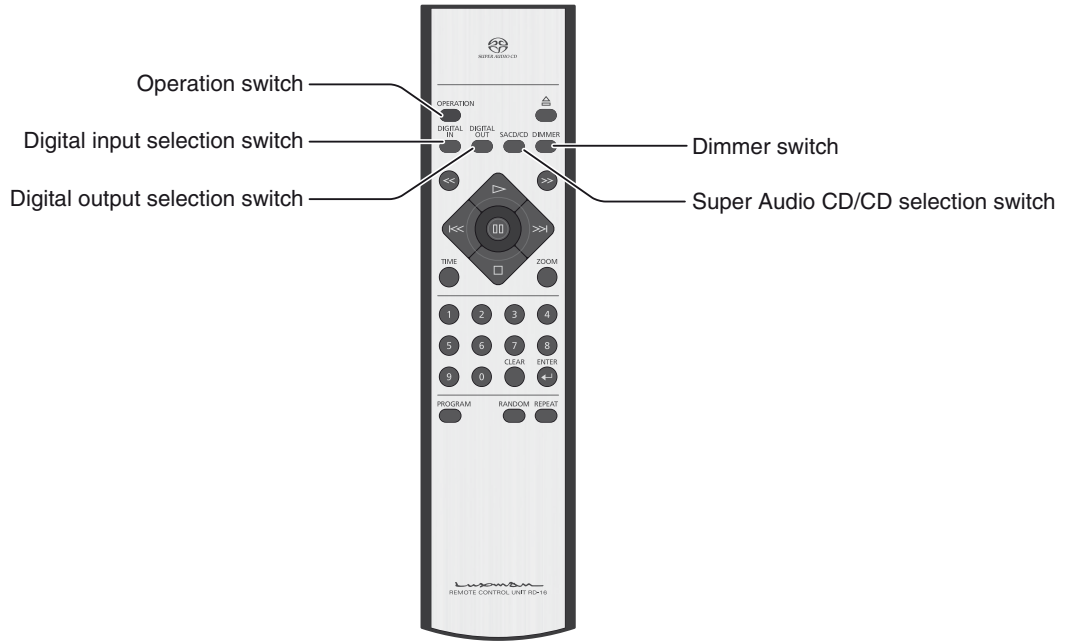



### Restore all the settings to the factory defaults.

All the settings are restored to the factory defaults.

1. Turn this unit to the standby state.
2. Press the OPERATION switch on the main unit while pressing the stop (■) switch on the main unit.

All the settings are restored to the factory defaults.

Item	Setting value
Digital input selection	INTERNAL (Internal player)
Digital output selection	On
Super Audio CD/CD selection	Super Audio CD (SACD)
Dimmer adjustment	Normal

### Last memory function (Memorization of each setting)

The following are the setting items to be memorized on the flash memory when the unit turns from the operating state to the standby state.

When power is turned off before the unit turns from the operating state to the standby state, it is regarded as the abnormal end. The setting items are restored to the factory defaults when the unit turns to the operating state next time.

Item	Setting value
Digital input selection	INTERNAL (Internal player), COAXIAL, OPTICAL
Digital output selection	ON, OFF
Super Audio CD/CD selection	Super Audio CD (SACD), CD
Dimmer adjustment	Normal, Darker, Significantly darker, No light

# BLOCK DIAGRAM

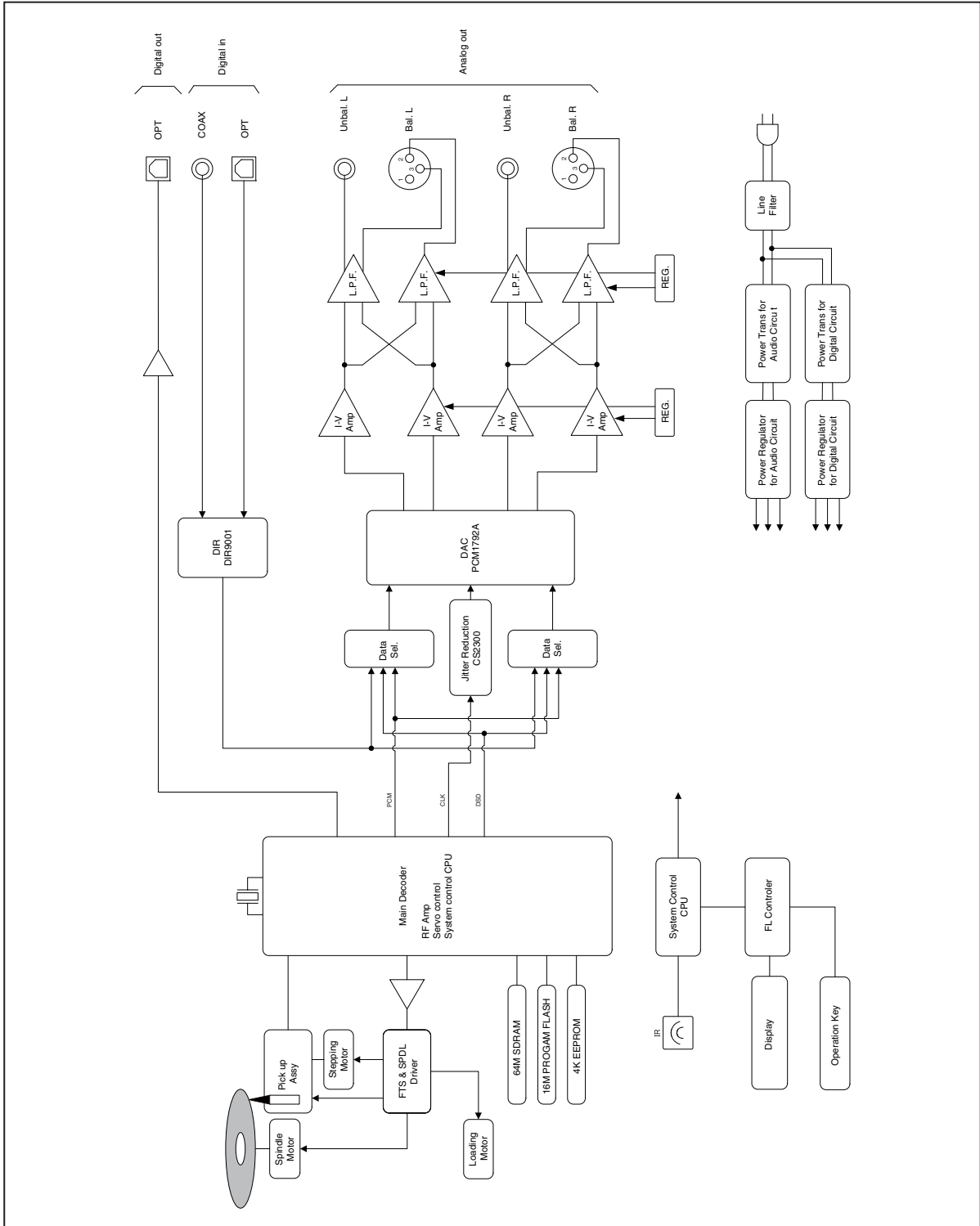

# Specifications

Format	2-channel Super Audio CD, CD		
Power source	AC 230 V, 50 Hz		
Power consumption	21 W 1 W (at standby)		
Weight (Main unit)	14.7 kg		
Dimensions	440 (W) × 133 (H) × 410 (D) mm		
Ambient operating temperature / Ambient operating humidity	+5 °C to +35 °C / 5 % to 85 % (non condensing)		
Audio output characteristics	Output voltage / output impedance:	UNBALANCE terminal (RCA terminal)	2.5 Vrms/300 Ω
		BALANCE terminal (XLR terminal)	2.5 Vrms/600 Ω
		For SACD/DSD (−0.5 dB)	2.35 Vrms
	Frequency response:	CD, DIGITAL IN	5 Hz to 20 kHz (+0, −0.4 dB)
		SACD	5 Hz to 50 kHz (+0, −3 dB)
	Total harmonic distortion:	CD	0.0014 %
		SACD	0.0017 %
		DIGITAL IN	0.0009 %
	S/N ratio:	CD	124 dB
		SACD	104 dB
		DIGITAL IN	122 dB
	Dynamic range:	CD	99 dB
	SACD	104 dB	
	DIGITAL IN	117 dB	
Channel separation:	CD	114 dB	
	SACD	103 dB	
	DIGITAL IN	118 dB	
Digital input	Coaxial digital input:	0.2 to 2.5 Vp-p	
	Optical digital input:	−14.5 to −24 dBm	
	Sampling frequency:	32 kHz, 44.1 kHz, 48 kHz, 88.2 kHz, 96 kHz (16 to 24 bit 2ch PCM at each frequency)	
Digital output	Optical digital output:	Optical digital terminal −15 to −21 dBm	

\* Design and specifications are subject to change without notice.

# Before You Ask For Repair Services

While the unit is used, an unusual phenomenon may be confused as a malfunction for a certain reason.

Prior to asking us for repair services, please check the table below and read the instruction manual for the subsidiary devices.

If the cause of malfunction cannot be identified, please make queries to the purchasing store.

Problem	Cause/Solution	Ref. page
Power is not turned on.	· Connect the power cable to the AC inlet (AC IN) and the AC outlet firmly.	22
The disc tray comes out even after the tray is closed.	· Set the disc on the disc tray correctly.	24
	· Clean the disc to remove dirt.	2
Playback cannot be performed.	· Clean the disc to remove dirt.	2
	· Set the disc on the disc tray correctly.	24
	· Remove dew condensation from the interior of this unit.	1
	· Put the disc on the tray with the label facing upwards.	
Settings have been erased.	· Settings may be erased when electric power failure happens or when power supply is shut down due to power cable disconnection. Be sure to unplug the power cable after pressing the OPERATION switch and the “-STANDBY-” disappears from the display.	46
The remote control cannot be operated.	· Operate the remote control within the specified operating range.	8
	· Replace the remote control battery with a new one.	7
	· The remote control infrared receiver is exposed to direct sunlight or strong light sources (such as inverter fluorescent lights). Change the installation place or angle to avoid the exposure to light sources.	8
An electronic device such as a television malfunctions.	· Some devices equipped with a wireless remote control receiver may malfunction when the remote control of this unit is operated. Keep this unit away from such devices.	8

Problem	Cause/Solution	Ref. page
No sound is generated from the speakers, or sound is distorted.	· Confirm that the connections of audio cables are correct.	22
	· If a digital output device is connected to this unit, set the setting of digital output to ON.	22
	· Clean the disc to remove dirt.	2
	· When the output level of an amplifier, etc. is minimum, adjust the volume.	
	· Confirm that the cable connectors are connected and firmly inserted into the terminals of the unit.	
	· Clean the cable connectors and terminals by using a plain dry cloth or a cloth dipped in a small amount of dehydrated alcohol.	22
Digital audio signals cannot be output digitally.	· Set the setting of digital output to ON.	44
	· It is impossible to output the digital audio signal when playing back the HD layer of Super Audio CD. Select the CD layer.	44
The output levels of SACD and CD are quite different.	· This is due to the difference in recording format.	

This unit may not work normally when the unit is subject to external influence such as static electricity. In such a case, the unit can work normally by unplugging the power cable once and plugging it again.

